

Metalgerätehaus



Bodenfundament

Montageanleitung

MF-X0810

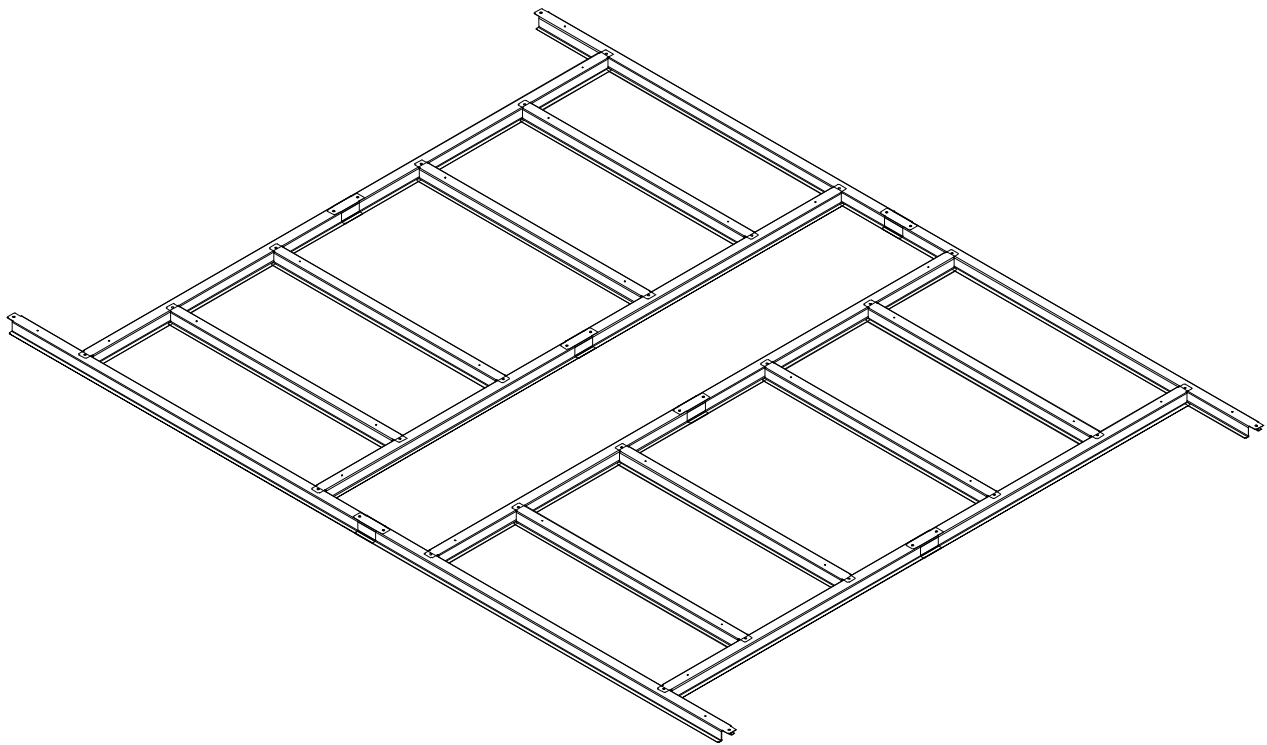





SICHERHEIT



Kunesco GmbH

E-mail: info@kunesco.de

www.kunesco.de

NO.	PART	Qty.
W1	 1473mm	4
W2	 854mm	8
W3	 837mm	8
F1		20

